

92mm sq.

San Ace 92

25mm thick (GA type), 25mm thick (S type)
 25mm thick, 25mm thick (San Cooler)
 32mm thick (G type), 38mm thick (GA type)
 38mm thick (GV type), 38mm thick (G type)



General Specifications

- Material Frame: Plastics (Flammability: UL94V-0),
 Impeller: Plastics (Flammability: UL94V-0)
- Expected Life Refer to specifications (L10:Survival rate:90% at 60°C ,
 rated voltage, and continuously run in a free air state)
- Lead Wire ⊕red ⊖black or blue (Sensor) yellow
- Storage Temperature -30°C to +70°C (Non-condensing)

92×92×25mm (Mass : 100g) **San Cooler**

Specifications

The following nos. **have pulse sensors and ribs**. For ribless, append "1" to the model no.

Model No.	Rated Voltage [V]	Operating Voltage Range [V]	Rated Current [A]	Rated Input [W]	Rated Speed [min ⁻¹]	Max. Air Flow [m ³ /min] [CFM]	Max. Static Pressure [Pa] [inchH ₂ O]	SPL [dB(A)]	Operating Temperature [°C]	Expected Life [h]
9A0912G401	12	6 to 13.8	0.39	4.68	3,900	1.76 62.1	66.5 0.267	43	-20 to +60	30,000
9A0912S401			0.27	3.24	3,550	1.66 58.6	56.1 0.225	39		
9A0912H401			0.21	2.52	3,150	1.45 51.2	44 0.177	33		
9A0912F401			0.14	1.68	2,650	1.24 43.8	32.2 0.129	30		
9A0912M401			0.12	1.44	2,250	1.04 36.7	22.6 0.091	27		
9A0912L401			0.07	0.84	1,750	0.8 28.2	13.4 0.054	23		
9A0924G401	24	12 to 27.6	0.19	4.56	3,900	1.76 62.1	66.5 0.267	43	-20 to +60	30,000
9A0924S401			0.15	3.6	3,550	1.66 58.6	56.1 0.225	39		
9A0924H401			0.1	2.4	3,150	1.45 51.2	44 0.177	33		
9A0924F401			0.08	1.92	2,650	1.24 43.8	32.2 0.129	30		
9A0924M401			0.05	1.2	2,250	1.04 36.7	22.6 0.091	27		
9A0924L401			0.04	0.96	1,750	0.8 28.2	13.4 0.054	23		
9A0948S401	48	40.5 to 53	0.08	3.84	3,550	1.66 58.6	56.1 0.225	39	-20 to +60	40,000

- Available options: ⇒ **Without Sensor**
- Please inquire as the availability of these functions depend on the model. ⇒ **Lock Sensor**

Dimensions (Unit : mm) (With ribs)

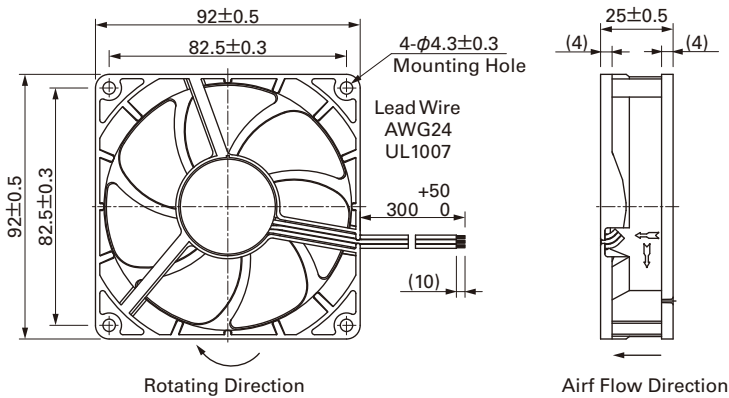

Options (Unit : mm)

Finger guards
 Model : 109-099C Surface treatment : Nickel-chrome plating (silver) Color : Silver

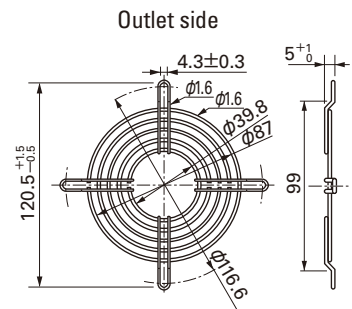

Reference dimension of mounting holes and vent opening (Unit : mm)

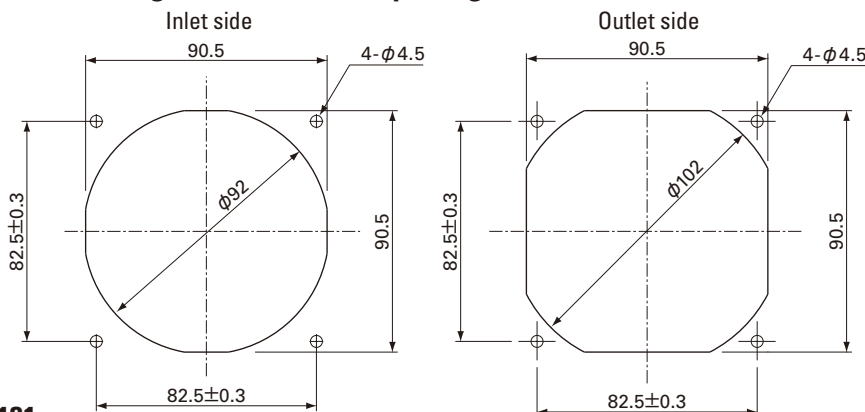

Model : 109-099E Surface treatment : Nickel-chrome plating (silver) Color : Silver
 : 109-099H : Cation electropainting (black)

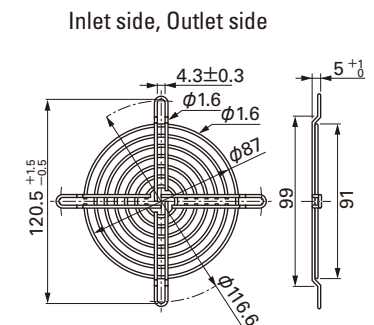

Options (Unit : mm)

Resin finger guards

Model : 109-1001G

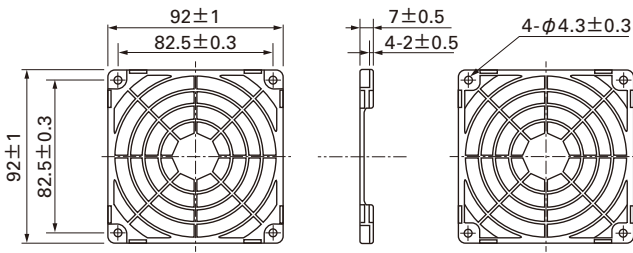

Resin filter kits

Model : 109-1001F13 (13PPI), 109-1001F20 (20PPI)
: 109-1001F30 (30PPI), 109-1001F40 (40PPI)

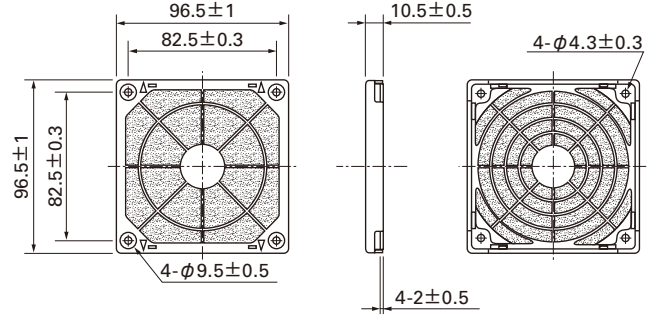

Air Flow - Static Pressure Characteristics

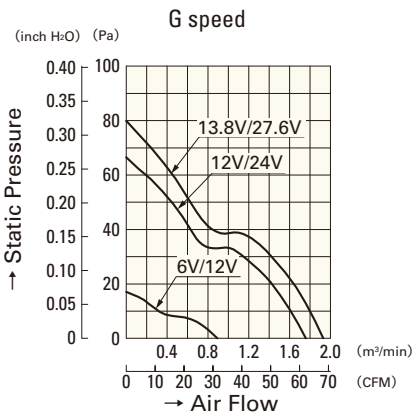

9A0912G401
9A0924G401

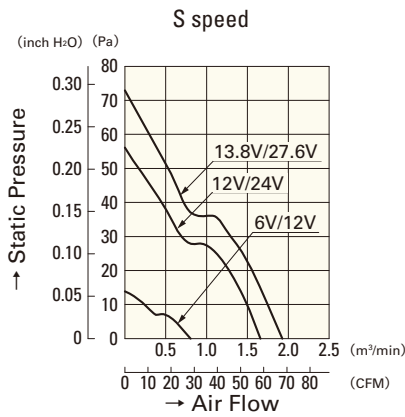

9A0912S401
9A0924S401

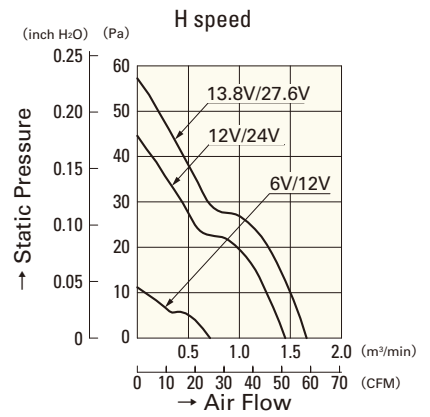

9A0912H401
9A0924H401

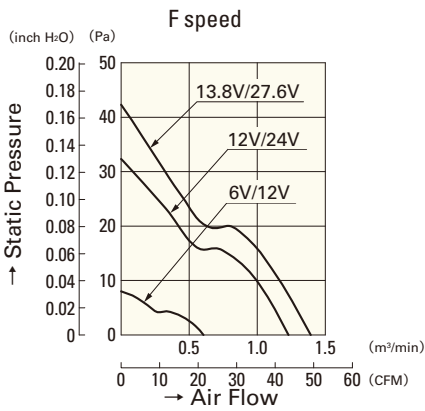

9A0912F401
9A0924F401

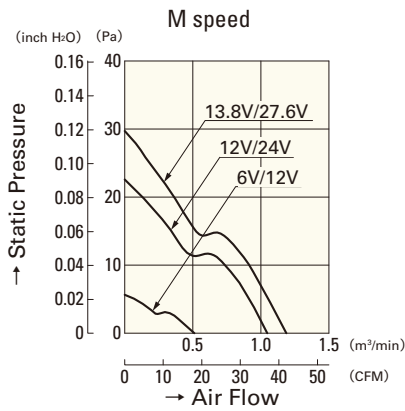

9A0912M401
9A0924M401

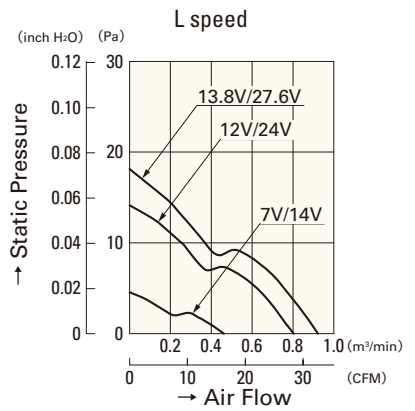

9A0912L401
9A0924L401

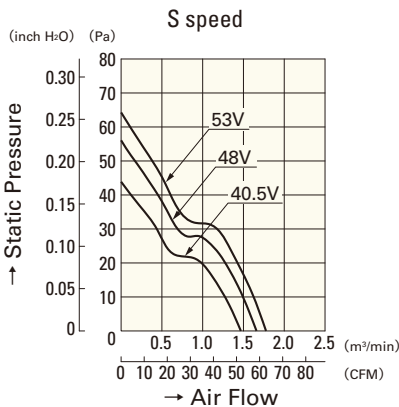

9A0948S401