

# 60×60×25 mm

San Ace 60 9R type   



## General Specifications

- Material ..... Frame: Plastic (Flammability: UL 94V-0), Impeller: Plastic (Flammability: UL 94V-1)
- Expected life ..... See the table below. (L10 life: 90% survival rate for continuous operation in free air at 60°C, rated voltage)
- Motor protection function ..... Locked rotor burnout protection, Reverse polarity protection  
For details, please refer to p. 547.
- Dielectric strength ..... 50/60 Hz, 500 VAC, for 1 minute (between lead wire conductors and frame)
- Insulation resistance ..... 10 MΩ or more with a 500 VDC megger (between lead wire conductors and frame)
- Sound pressure level (SPL) ..... At 1 m away from the air inlet
- Storage temperature ..... -30 to +70°C (Non-condensing)
- Lead wire ..... ⊕Red ⊖Black or Blue (Sensor) Yellow
- Mass ..... 90 g

## Specifications

The models listed below **have ribs and pulse sensors**. For models without ribs, append "1" to the end of model numbers.

Model no.	Rated voltage [V]	Operating voltage range [V]	Rated current [A]	Rated input [W]	Rated speed [min <sup>-1</sup> ]	Max. airflow [m <sup>3</sup> /min]	Max. airflow [CFM]	Max. static pressure [Pa]	Max. static pressure [inchH <sub>2</sub> O]	SPL [dB (A)]	Operating temperature [°C]	Expected life [h]	
109R0605H401	5	4.5 to 5.5	0.34	1.7	3800	0.53	18.7	40.2	0.161	28	-20 to +70	60000/60°C	
109R0605F401			0.2	1.0	3200	0.44	15.5	29.4	0.118	24	-20 to +60		
109R0605M401			0.13	0.65	2600	0.36	12.7	19.6	0.079	20	-20 to +70		
109R0612J401	12	10.8 to 13.2	0.47	5.64	7600	1.06	37.1	155.0	0.622	44	-20 to +60	40000/60°C	
109R0612G401			0.24	2.88	5600	0.78	27.5	87.3	0.351	39	-20 to +70		60000/60°C
109R0612D401		10.2 to 13.8	0.21	2.52	5150	0.72	25.4	73.5	0.295	37			
109R0612S401			6 to 13.8	0.17	2.04	4600	0.65	23.0	56.8	0.228		33	
109R0612H401		0.11		1.32	3800	0.53	18.7	40.1	0.161	28			
109R0612F401		0.09		1.08	3200	0.44	15.5	29.4	0.118	24			
109R0612M401		7 to 13.8	0.06	0.72	2600	0.36	12.7	19.6	0.079	20			
109R0624J401		24	21.6 to 26.4	0.24	5.76	7600	1.06	37.1	155.0	0.622		44	
109R0624G401			20.4 to 27.6	0.13	3.12	5600	0.78	27.5	87.3	0.351	39	-20 to +70	
109R0624D401	12 to 27.6		0.12	2.88	5150	0.72	25.4	73.5	0.295	37			
109R0624S401			0.08	1.92	4600	0.65	23.0	56.8	0.228	33			
109R0624H401			0.06	1.44	3800	0.53	18.7	40.2	0.161	28			
109R0624F401	0.05		1.2	3200	0.44	15.5	29.4	0.118	24				
109R0624M401	14 to 27.6		0.04	0.96	2600	0.36	12.7	19.6	0.079	20			
109R0648J401	48		43.2 to 52.8	0.12	5.76	7600	1.06	37.1	155.0	0.622	44	-20 to +60	40000/60°C
109R0648G401		43 to 53	0.07	3.36	5600	0.78	27.5	87.3	0.351	39			
109R0648H401		40 to 53	0.04	1.92	3800	0.53	18.7	40.2	0.161	28	-20 to +70	60000/60°C	

The following sensor and control options are available for selection.

Available for all models. **Without sensor**

Differs according to the model. Refer to the table on p. 564. **Lock sensor** **PWM control**

JIAN 健策

0755—23706799

微信扫码  
咨询工程师



# Airflow - Static Pressure Characteristics

**109R0605H401** With pulse sensor

Operating voltage range

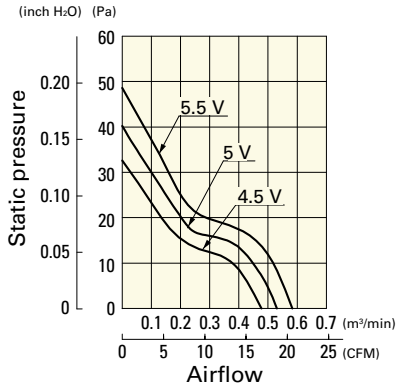

**109R0605F401** With pulse sensor

Operating voltage range

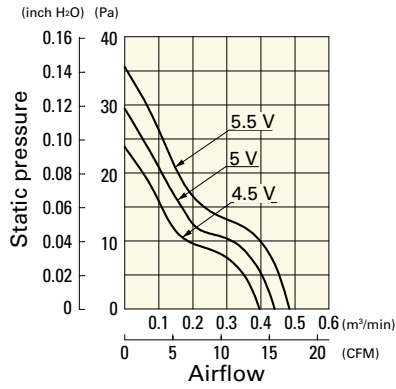

**109R0605M401** With pulse sensor

Operating voltage range

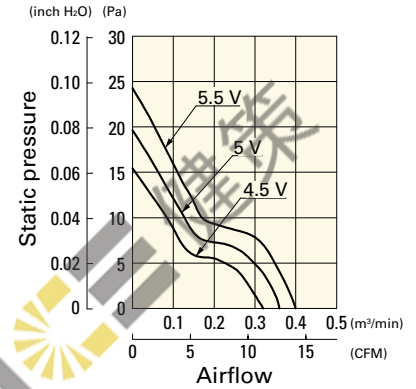

**109R0612J401** With pulse sensor

Operating voltage range

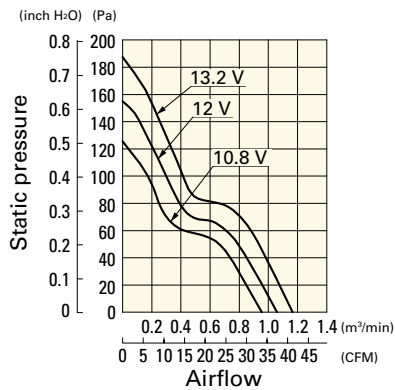

**109R0612G401** With pulse sensor

Operating voltage range

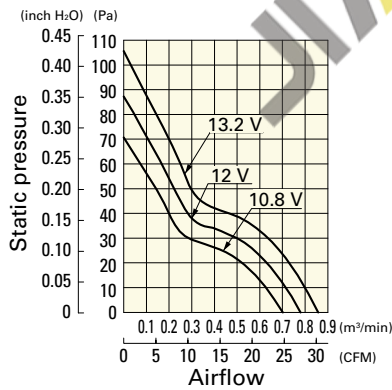

**109R0612D401** With pulse sensor

Operating voltage range

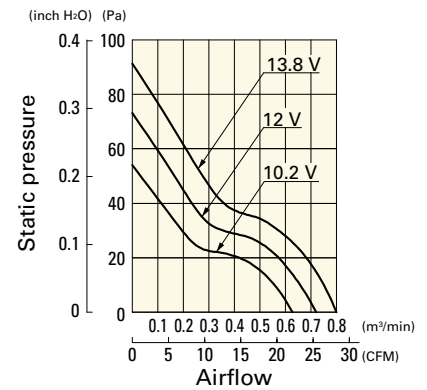

**109R0612S401** With pulse sensor

Operating voltage range

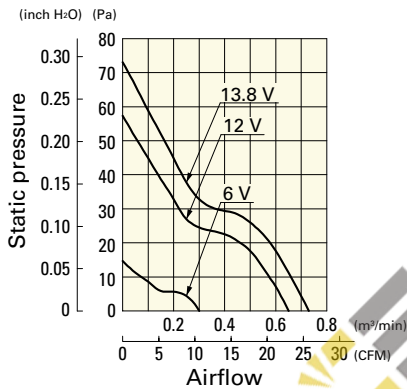

**109R0612H401** With pulse sensor

Operating voltage range

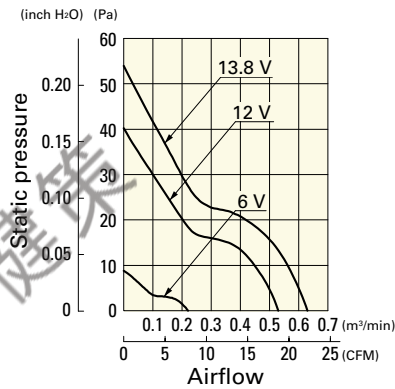

**109R0612F401** With pulse sensor

Operating voltage range

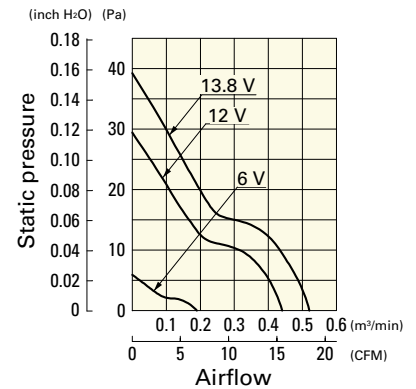

**109R0612M401** With pulse sensor

Operating voltage range

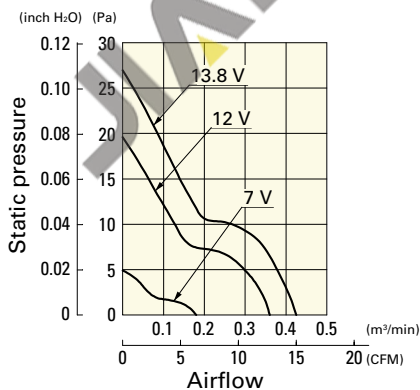

**109R0624J401** With pulse sensor

Operating voltage range

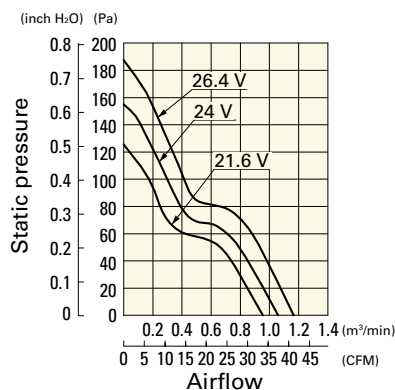

**109R0624G401** With pulse sensor

Operating voltage range

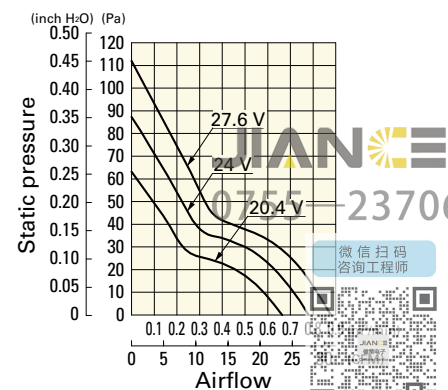

# Airflow - Static Pressure Characteristics

**109R0624D401** With pulse sensor

Operating voltage range

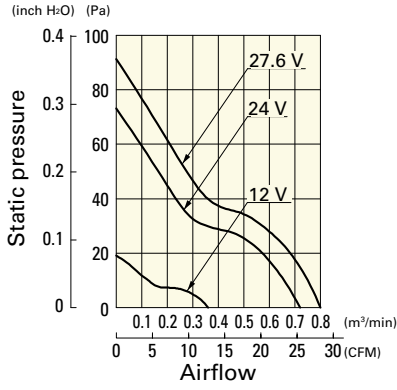

**109R0624S401** With pulse sensor

Operating voltage range

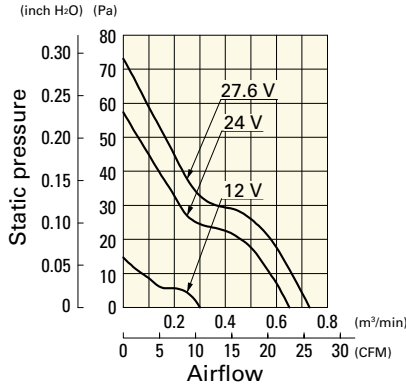

**109R0624H401** With pulse sensor

Operating voltage range

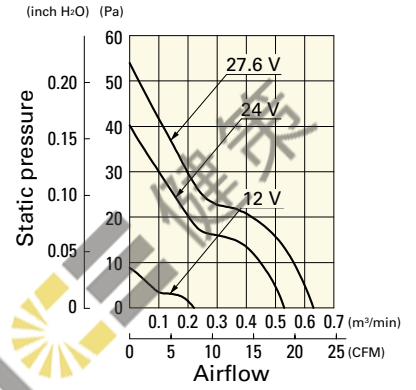

**109R0624F401** With pulse sensor

Operating voltage range

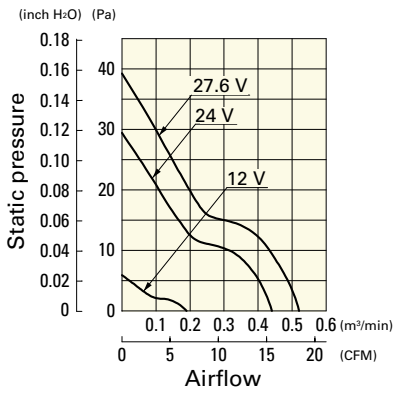

**109R0624M401** With pulse sensor

Operating voltage range

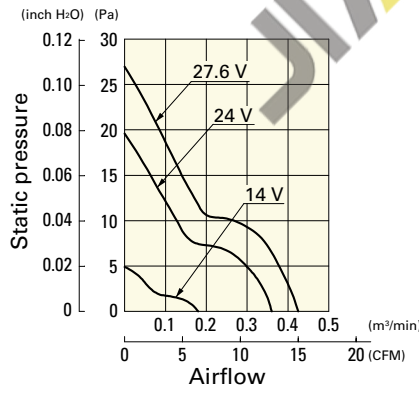

**109R0648J401** With pulse sensor

Operating voltage range

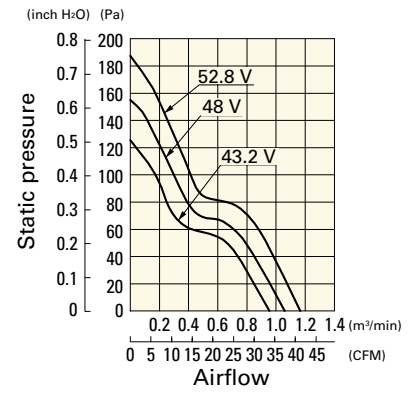

**109R0648G401** With pulse sensor

Operating voltage range

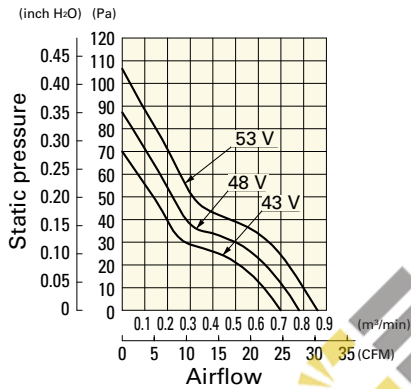

**109R0648H401** With pulse sensor

Operating voltage range

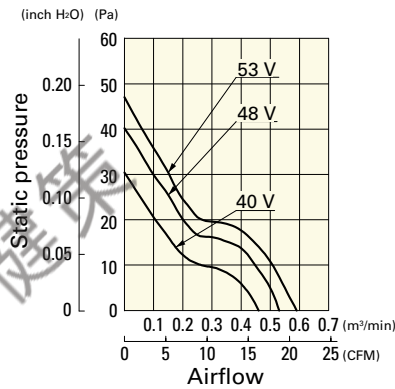

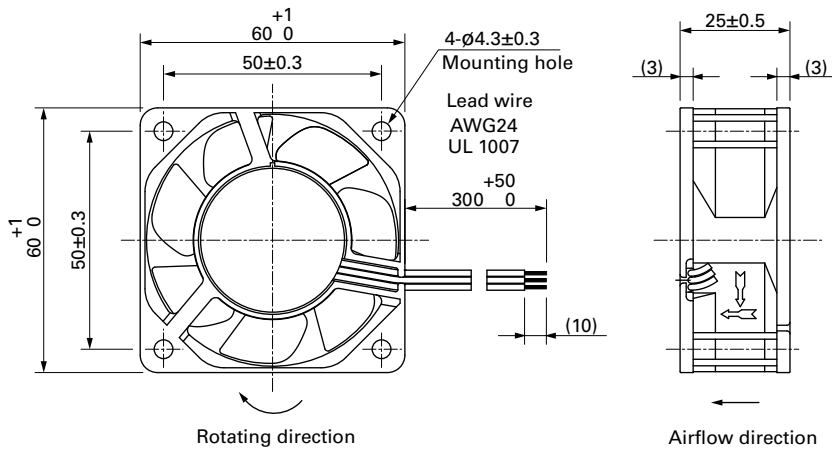
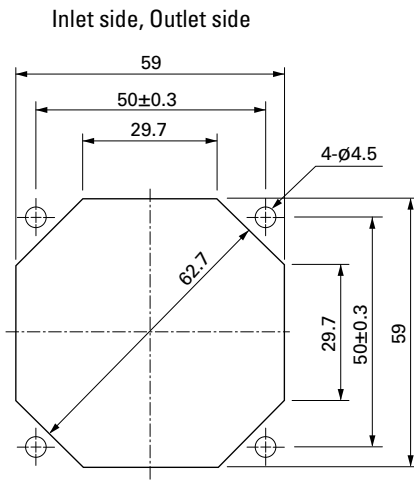
**Dimensions (unit: mm)** (With ribs)**Reference Dimensions of Mounting Holes and Vent Opening (unit: mm)****Options****Finger guards**

page: p. 532

Model no.: 109-139E, 109-139H

**Resin finger guards**

page: p. 539

Model no.: 109-1003G

**Resin filter kits**

page: p. 540

Model no.: 109-1003F13 (13PPI), 109-1003F20 (20PPI),  
109-1003F30 (30PPI), 109-1003F40 (40PPI)



# Mouser Electronics

Authorized Distributor

Click to View Pricing, Inventory, Delivery & Lifecycle Information:

## Sanyo Denki:

[109R0605M4021](#) [109R0612F402](#) [109R0624F402](#) [109R0624J401](#) [109R0624M4011](#) [109R0624S4021](#)  
[109R0605H4011](#) [109R0605M4011](#) [109R0612D4011](#) [109R0612G4011](#) [109R0612H4011](#) [109R0612M4011](#)  
[109R0612S4011](#) [109R0605H401](#) [109R0605M401](#) [109R0612D401](#) [109R0624D401](#) [109R0648H401](#) [109R0648J401](#)  
[109R0605F402](#) [109R0605M402](#) [109R0612D402](#) [109R0612J402](#) [109R0612S402](#) [109R0624S402](#) [109R0648G402](#)  
[109R0605H4021](#) [109R0612G4021](#) [109R0624G4021](#) [109R0612J4021](#) [109R0624G402](#) [109R0624G401](#)  
[109R0648H4011](#) [109R0605F401](#) [109R0624J4011](#) [109R0648G401](#) [109R0624F401](#) [109R0612S4021](#)  
[109R0648H4021](#) [109R0624F4021](#) [109R0624H402](#) [109R0612G402](#) [109R0624M401](#) [109R0612H4021](#)  
[109R0605H402](#) [109R0612M4021](#) [109R0612M402](#) [109R0612H402](#) [109R0612F4021](#) [109R0612G401](#)  
[109R0624H4021](#) [109R0648H402](#) [109R0612J401](#) [109R0624S401](#) [109R0612S401](#) [109R0612J4011](#)  
[109R0624D4011](#) [109R0624H4011](#) [109R0624H401](#) [109R0612H401](#) [109R0612M401](#) [109R0624F4011](#)  
[109R0612F401](#) [109R0624G4011](#) [109R0648J4011](#) [109R0648G4011](#) [109R0612F4011](#) [109R0648G4D011](#)  
[109R0648H4D01](#) [109R0624S4D01](#) [109R0612J4D011](#) [109R0624S4D011](#) [109R0624M402](#) [109R0624H4D011](#)  
[109R0624J402](#) [109R0624H4D01](#) [109R0624G4D01](#) [109R0648H4D011](#) [109R0648J402](#) [109R0648J4021](#)  
[109R0648J4D01](#) [109R0612S4D01](#) [109R0648G4D01](#) [109R0612F4D011](#) [109R0648G4021](#) [109R0605F4021](#)  
[109R0612F4D01](#) [109R0624M4D01](#) [109R0624M4D011](#) [109R0612G4D01](#) [109R0612G4D011](#) [109R0624D402](#)  
[109R0624D4D01](#) [109R0624G4D011](#) [109R0612M4D01](#) [109R0612S4D011](#) [109R0624M4021](#) [109R0624F4D01](#)  
[109R0612M4D011](#) [109R0624F4D011](#)



**JIAN 健策**  
0755—23706799

