

# 40x40x28 mm

San Ace 40 9P type    Model 109P0424R3013 is not certified.



## General Specifications

- Material ..... Frame: Plastic (Flammability: UL 94V-0), Impeller: Plastic (Flammability: UL 94V-1)
- Expected life ..... See the table below. (L10 life: 90% survival rate for continuous operation in free air at 60°C, rated voltage)
- Motor protection function ..... Locked rotor burnout protection, Reverse polarity protection  
For details, please refer to p. 547.
- Dielectric strength ..... 50/60 Hz, 500 VAC, for 1 minute (between lead wire conductors and frame)
- Insulation resistance ..... 10 MΩ or more with a 500 VDC megger (between lead wire conductors and frame)
- Sound pressure level (SPL) ..... At 1 m away from the air inlet
- Storage temperature ..... -30 to +70°C (Non-condensing)
- Lead wire ..... ⊕Red ⊖Black or Blue (Sensor) Yellow
- Mass ..... 52 g

## Specifications

The models listed below **have ribs and pulse sensors.**

Model no.	Rated voltage [V]	Operating voltage range [V]	Rated current [A]	Rated input [W]	Rated speed [min <sup>-1</sup> ]	Max. airflow [m <sup>3</sup> /min] [CFM]	Max. static pressure [Pa] [inchH <sub>2</sub> O]	SPL [dB (A)]	Operating temperature [°C]	Expected life [h]
109P0405H3013	5	4.5 to 5.5	0.68	3.4	8700	0.32 11.3	102.9 0.414	37	-20 to +70	40000/60°C
109P0405F3013			0.28	1.4	6700	0.244 8.6	58.8 0.236	30		60000/60°C
109P0412K3013	12	8 to 13.2	0.55	6.6	15500	0.59 20.8	340 1.365	50	-20 to +60	40000/60°C
109P0412J3013		7 to 13.2	0.35	4.2	12500	0.46 16.2	210 0.843	44		
109P0412G3013		7 to 13.8	0.31	3.72	11500	0.42 14.8	179 0.719	42		
109P0412B3013			0.28	3.36	10300	0.38 13.4	143 0.574	40		
109P0412H3013		7 to 13.8	0.195	2.34	8700	0.32 11.3	102.9 0.414	37	-20 to +70	60000/60°C
109P0412F3013			0.105	1.26	6700	0.244 8.6	58.8 0.236	30		
109P0412M3013		10.2 to 13.8	0.045	0.54	4100	0.15 5.3	21.6 0.087	20		
109P0424R3013		24	12 to 26.4	0.25	6	14000	0.51 18.0	263.4 1.057	47	-20 to +60
109P0424J3013	0.18			4.32	12500	0.46 16.2	210 0.843	44		
109P0424G3013	0.19			4.56	11500	0.42 14.8	179 0.719	42		
109P0424B3013	12 to 27.6		0.13	3.12	10300	0.38 13.4	143 0.574	40	-20 to +70	60000/60°C
109P0424H3013			0.095	2.28	8700	0.32 11.3	102.9 0.414	37		
109P0424F3013	14 to 27.6		0.055	1.32	6700	0.244 8.6	58.8 0.236	30		

The following sensor and control options are available for selection.

Available for all models. **Without sensor**

Differs according to the model. Refer to the table on pp. 562 to 563. **Lock sensor** **PWM control**

## Airflow - Static Pressure Characteristics

109P0405H3013 With pulse sensor

Operating voltage range

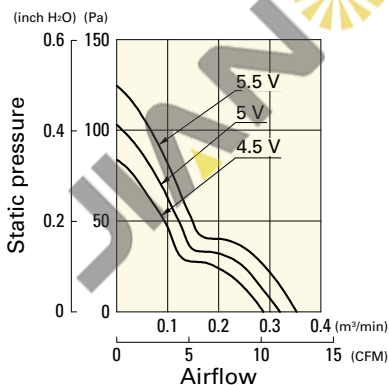

109P0405F3013 With pulse sensor

Operating voltage range

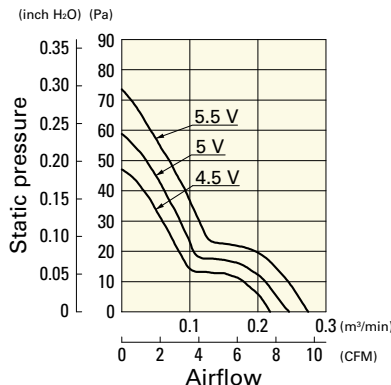

109P0412K3013 With pulse sensor

Operating voltage range

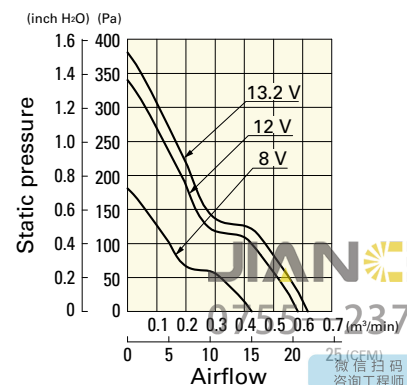

JIAN 健策

33706799

微信扫码 咨询工程师

# Airflow - Static Pressure Characteristics

**109P0412J3013** With pulse sensor

Operating voltage range

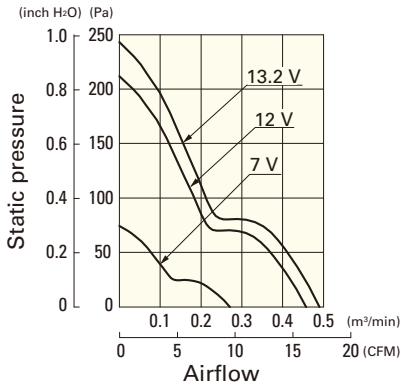

**109P0412G3013** With pulse sensor

Operating voltage range

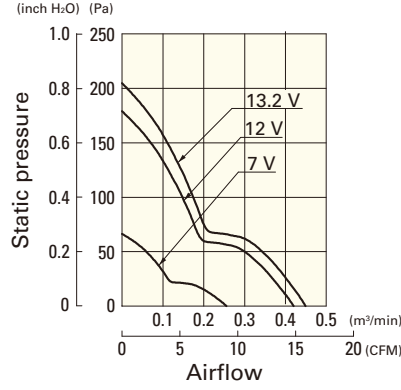

**109P0412B3013** With pulse sensor

Operating voltage range

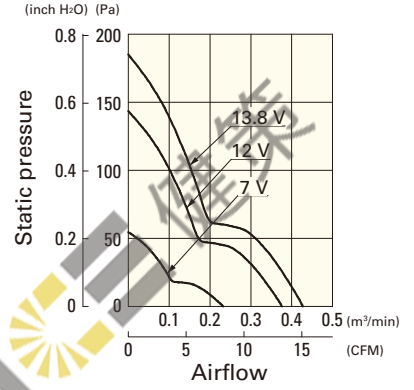

**109P0412H3013** With pulse sensor

Operating voltage range

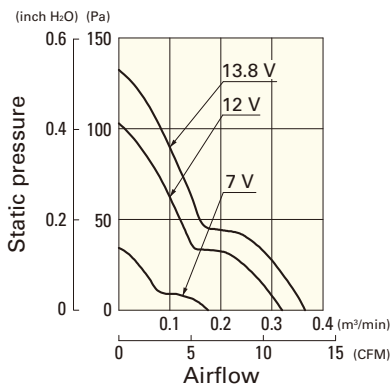

**109P0412F3013** With pulse sensor

Operating voltage range

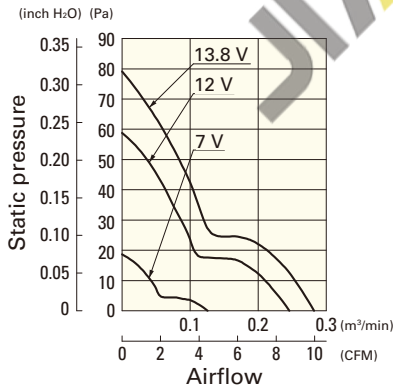

**109P0412M3013** With pulse sensor

Operating voltage range

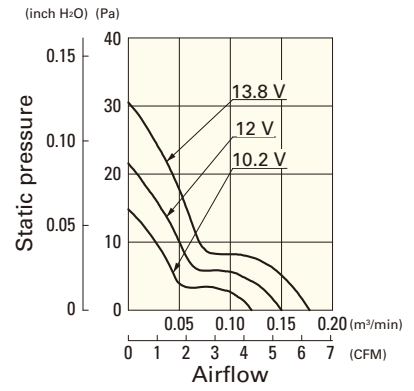

**109P0424R3013** With pulse sensor

Operating voltage range

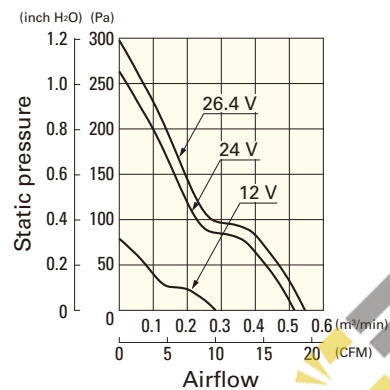

**109P0424J3013** With pulse sensor

Operating voltage range

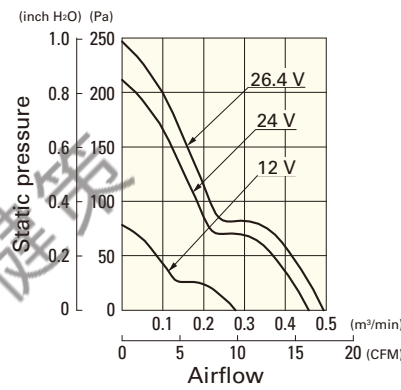

**109P0424G3013** With pulse sensor

Operating voltage range

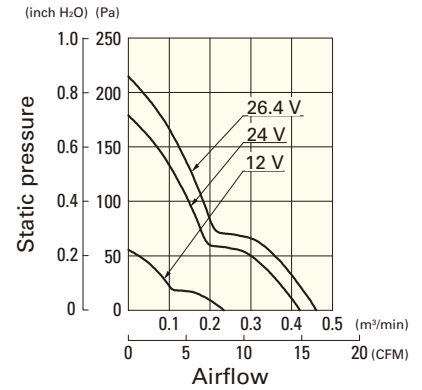

**109P0424B3013** With pulse sensor

Operating voltage range

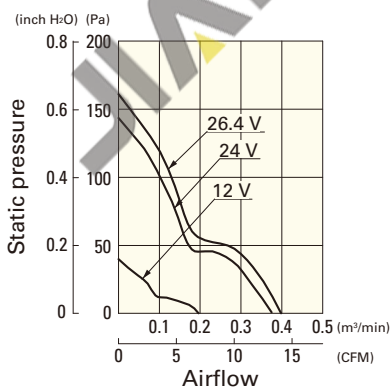

**109P0424H3013** With pulse sensor

Operating voltage range

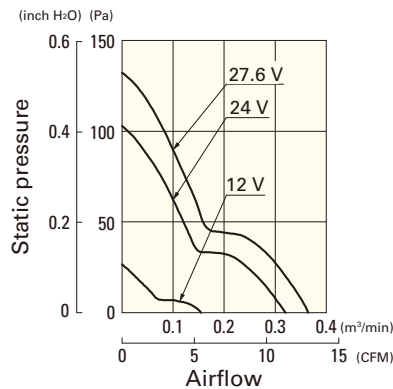

**109P0424F3013** With pulse sensor

Operating voltage range

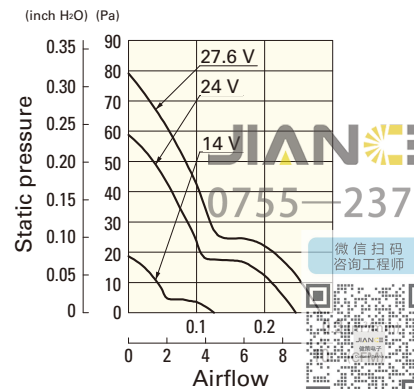

JIAN 健策  
0755-23706799  
微信扫码  
咨询工程师

**Dimensions (unit: mm)**

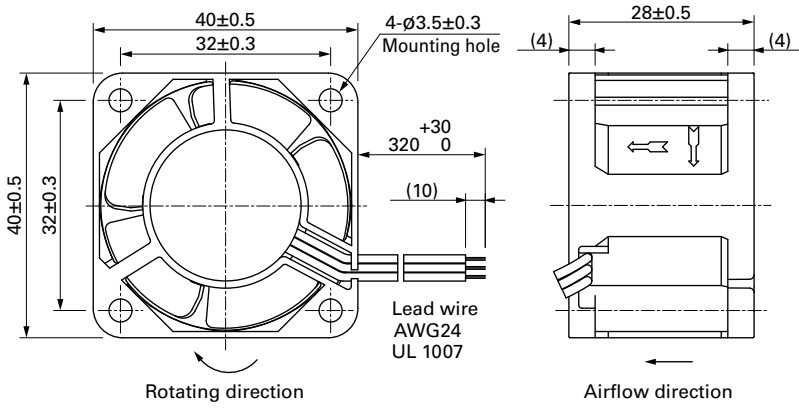

**Reference Dimensions of Mounting Holes and Vent Opening (unit: mm)**

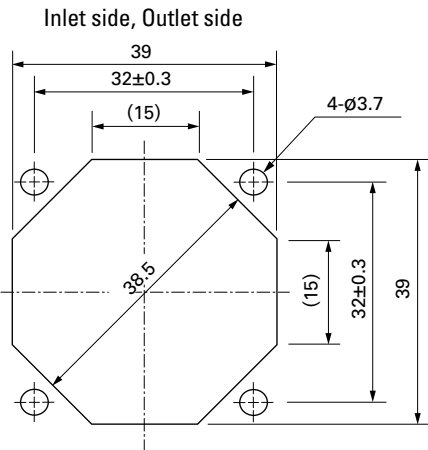

**Options**

Finger guards

page: p. 532

Model no.: 109-059, 109-059H



# Mouser Electronics

Authorized Distributor

Click to View Pricing, Inventory, Delivery & Lifecycle Information:

## Sanyo Denki:

[109P0405F3013](#) [109P0405H3013](#) [109P0412B3013](#) [109P0412F3013](#) [109P0412G3013](#) [109P0412H3013](#)  
[109P0412J3013](#) [109P0412K3013](#) [109P0412M3013](#) [109P0424B3013](#) [109P0424F3013](#) [109P0424G3013](#)  
[109P0424H3013](#) [109P0424J3013](#) [109P0424H3023](#) [9PH0412P3K033](#) [109P0412B3023](#) [109P0424J3023](#)  
[109P0405H3023](#) [109P0412F3023](#) [109P0412G3023](#) [109P0412K3023](#) [109P0424R3013](#) [109P0412F3D013](#)  
[109P0412H3023](#) [109P0424H3D013](#) [109P0412M3D013](#) [109P0412H3D013](#) [109P0424G3D013](#) [109P0412K3D013](#)  
[109P0424G3023](#) [109P0424F3023](#) [109P0424B3D013](#) [109P0424J3D013](#) [109P0412J3D013](#) [109P0424B3023](#)  
[109P0412J3023](#) [109P0424F3D013](#) [109P0412G3D013](#) [109P0412M3023](#) [109P0412B3D013](#) [109P0405F3D013](#)  
[109P0405F3023](#) [109P0405H3D013](#) [9PH0412P3J013](#) [109P0412P3B013](#) [109P0424R3023](#)

JIAN 健策

JIAN 健策  
0755—23706799

