

∅ 100x25 mm

San Ace 100W 9W2TM type 

DC Splash Proof Centrifugal Fan ∅100 mm

General Specifications

- Material Motor case: Aluminum (Black coating), Impeller: Plastic (Flammability: UL 94V-0)
- Expected life See the table below. (L10 life: 90% survival rate for continuous operation in indoor free air at 60°C, rated voltage)
Expected life at 40°C is for reference only.
- Motor protection function Locked rotor burnout protection, Reverse polarity protection
For details, please refer to p. 608.
- Dielectric strength 50/60 Hz, 500 VAC, for 1 minute (between lead wire conductors and motor case)
- Insulation resistance 10 MΩ min. at 500 VDC (between lead wire conductors and motor case)
- Sound pressure level (SPL) A-weighted sound pressure level (SPL) at 1 m away from the air inlet.
- Storage temperature -30 to +70°C (Non-condensing)
- Lead wire ⊕Red ⊖Black Sensor Yellow Control Brown
- Mass 190 g
- Ingress protection IP68 For more information on IP rating, refer to p. 617.

Specifications When the optional inlet nozzle (109-1080H) is mounted.

The models listed below **have a pulse sensor with PWM control.**

Model no.	Rated voltage [V]	Operating voltage range [V]	PWM duty cycle [%]	Rated current [A]	Rated input [W]	Rated speed [min ⁻¹]	Max. airflow [m ³ /min] [CFM]	Max. static pressure [Pa] [inchH ₂ O]	SPL [dB (A)]	Operating temperature [°C]	Expected life [h]
9W2TM24P4G001	24	18 to 27.6	100	0.7	16.8	7400	2.03 71.7	708 2.84	65	-20 to +70	40000/60°C (70000/40°C)
			20	0.04	0.96	1500	0.39 14	30 0.12	31		
9W2TM24P4H001	24	18 to 27.6	100	0.44	10.56	6400	1.77 62.5	560 2.25	60		
			20	0.04	0.96	1500	0.39 14	30 0.12	31		
9W2TM48P4G001	48	36 to 60	100	0.35	16.8	7400	2.03 71.7	708 2.84	65		
			20	0.04	1.92	1500	0.39 14	30 0.12	31		
9W2TM48P4H001	48	36 to 60	100	0.22	10.56	6400	1.77 62.5	560 2.25	60		
			20	0.04	1.92	1500	0.39 14	30 0.12	31		

* PWM frequency is 25 kHz. Models without ratings for 0% PWM duty cycle have zero speed at 0%. When control terminal is open, speed is the same as at 100% duty cycle.

Note 1: Sensor and control options are available for selection. Refer to the table on p. 650.

Note 2: The  mark indicates Short LeadTime Service applicable models. See p. 664 for details.

Airflow - Static Pressure Characteristics / PWM Duty - Speed Characteristics Example

9W2TM24P4G001 With pulse sensor with PWM control

PWM duty cycle

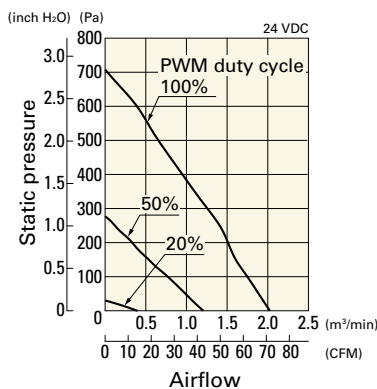

Operating voltage range

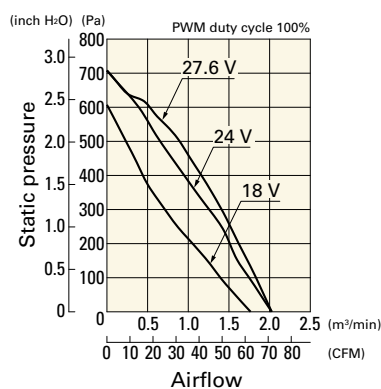

PWM duty - Speed characteristics example

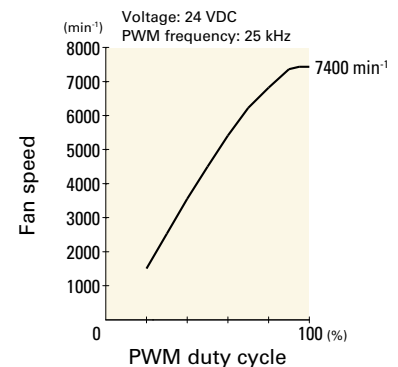

Airflow - Static Pressure Characteristics / PWM Duty - Speed Characteristics Example

9W2TM24P4H001 With pulse sensor with PWM control

PWM duty cycle

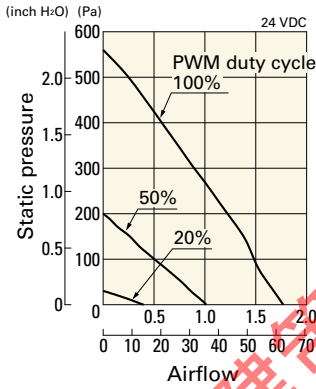

Operating voltage range

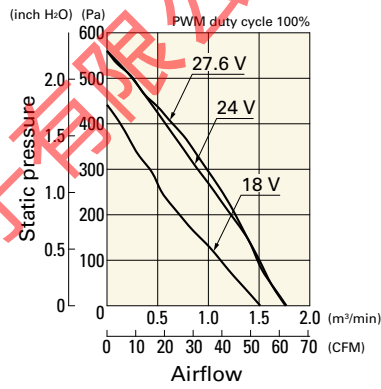

PWM duty - Speed characteristics example

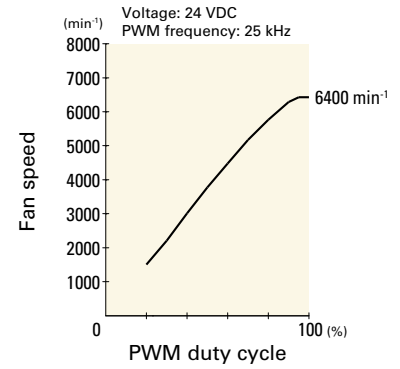

9W2TM48P4G001 With pulse sensor with PWM control

PWM duty cycle

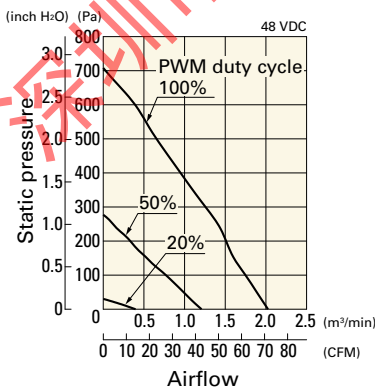

Operating voltage range

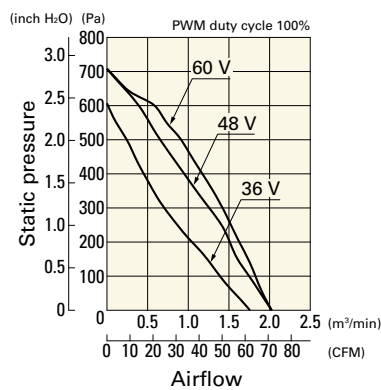

PWM duty - Speed characteristics example

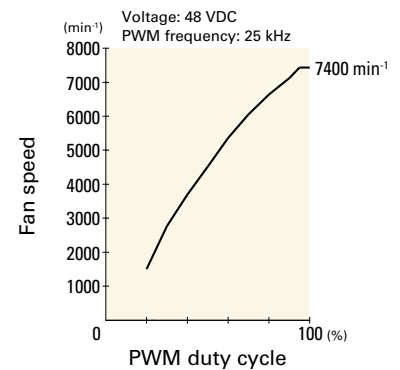

9W2TM48P4H001 With pulse sensor with PWM control

PWM duty cycle

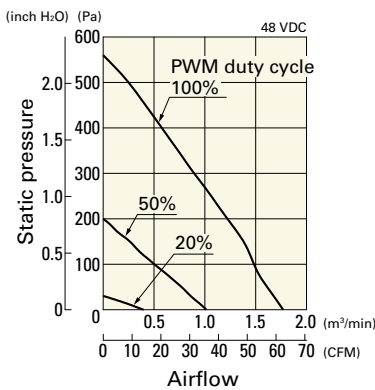

Operating voltage range

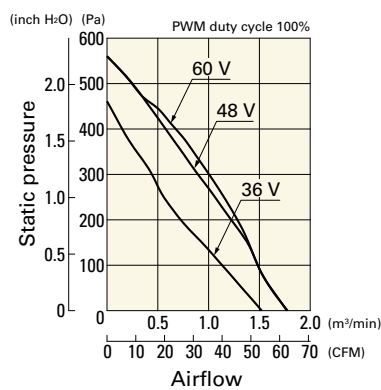

PWM duty - Speed characteristics example

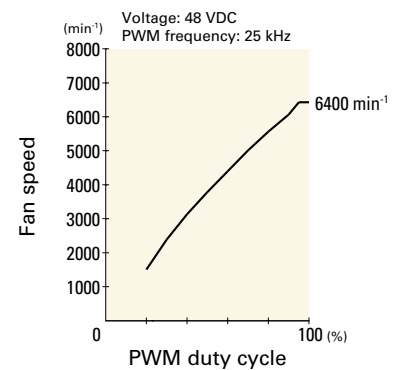

Dimensions (unit: mm)

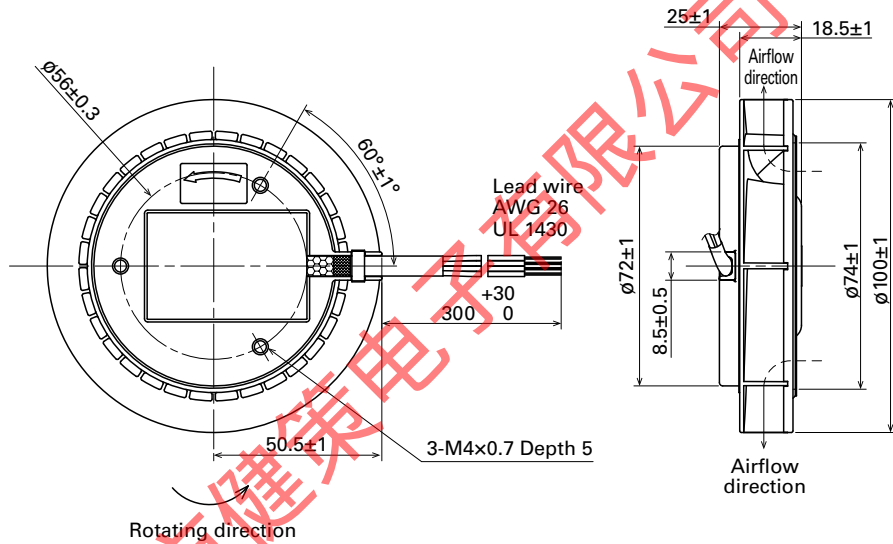

Reference Dimensions of Mounting Holes and Vent Opening (unit: mm)

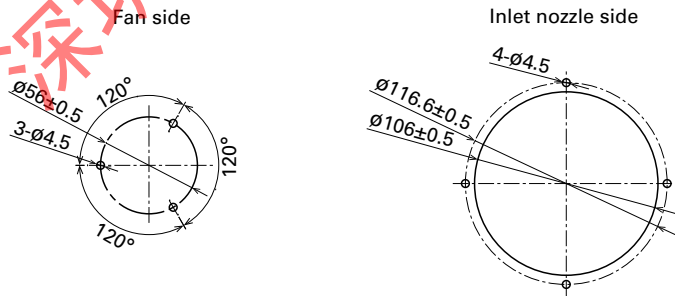

Reference Diagram for Mounting (unit: mm)

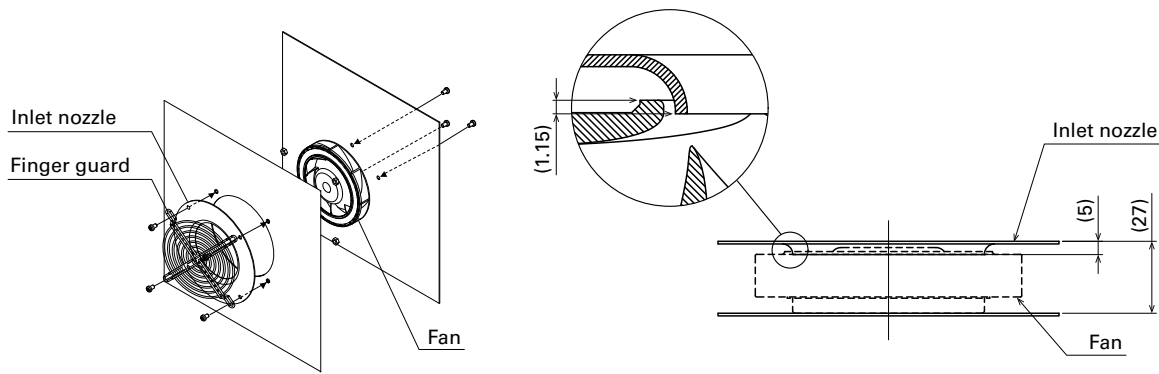

Options

Finger guards

page: p. 591

Model no.: 109-099E, 109-099H

Inlet nozzle

page: p. 595

Model no.: 109-1080, 109-1080H